

Miniatur Radial Gebläse
Miniature Radial Blower
Ventilateur miniature radial

SN EN ISO 9001 CERTIFICATED

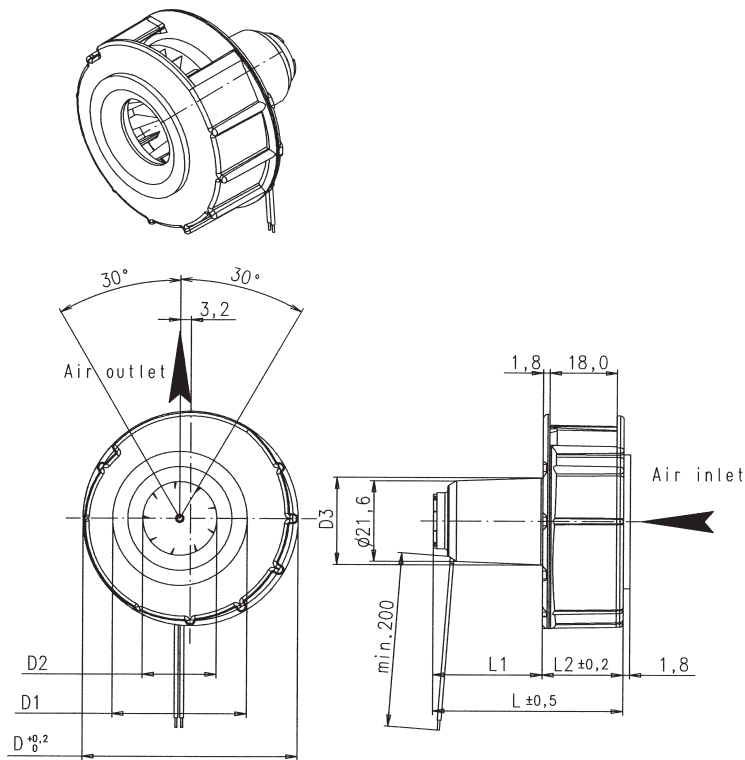

U64LM-006GK-2 6 V DC

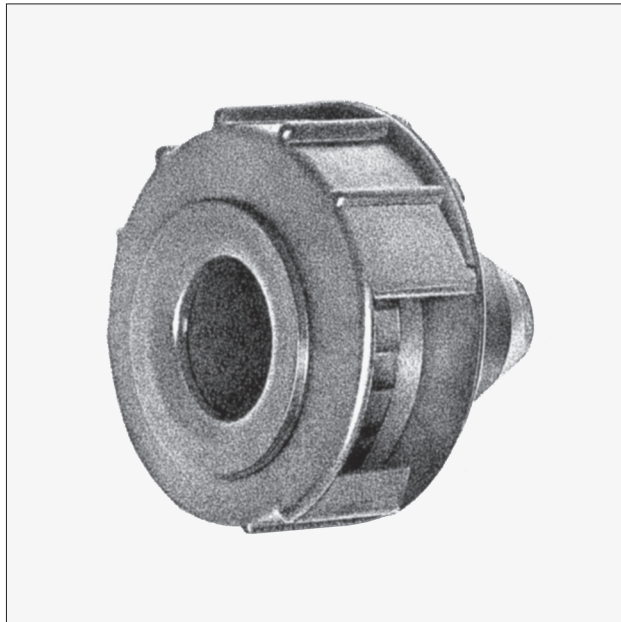
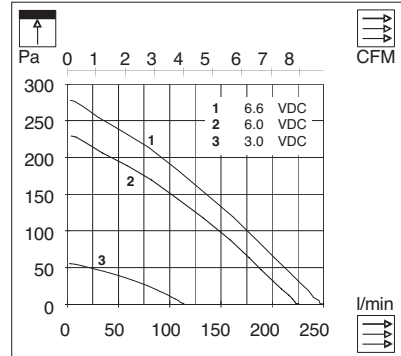

U64LM-012GK-2 12 V DC

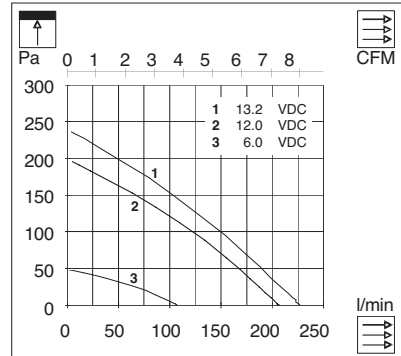



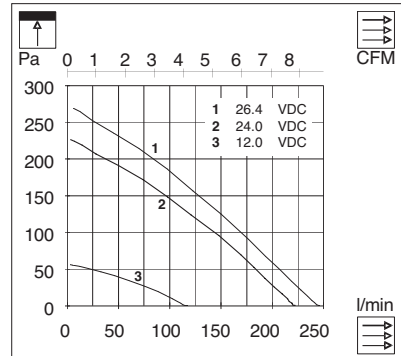

























U64LM-024GK-2 24 V DC



U64LM	mm	inch
D	$\phi 64$	$\phi 2.520$
D1	$\phi 40$	$\phi 1.575$
D2	$\phi 22$	$\phi 0.866$
D3	$\phi 26$	$\phi 1.024$
L	56.5	2.224
L1	32.5	1.279
L2	24	0.945

U64LM

Technische Daten
Technical data
Caractéristiques techniques

			U64LM-006GK-2	U64LM-012GK-2	U64LM-024GK-2
	U_N	V	6	12	24
	U	V	3 - 6.6	6 - 13.2	12 - 26.4
	I_N	mA	200	82	45
	I_N	mA	155	63	34
	I_N	mA	80	35	17
	I_{block}	A	1.6	6.2	0.33
	P_N	W	0.93	0.76	0.82
	n	min ⁻¹	7500	7000	7300
	n	min ⁻¹	7900	7350	7700
	n	min ⁻¹	8450	7900	8300
	\dot{V}	l/min; CFM	225/7.94	205/7.24	220/7.77
	\dot{V}	l/min; CFM	110/3.88	102/3.60	108/3.81
	p	Pa	140	118	137
	p	Pa	230	195	225
	LpA	dB(A)	46 - 53	49 - 56	50 - 54
	MTTF	hr	4000	4000	4000
	T	°C/F	-20...+65/-5...+150F	-20...+65/-5...+150F	-20...+65/-5...+150F
	m	gr/oz.	80/2.82	80/2.82	80/2.82
	Lead Length	mm/inch		200/7.87 (AWG 24)	
	Housing Material		PPO UL-94V-1	PPO UL-94V-1	PPO UL-94V-1
	Sleeve Bearing		●	●	●
	Ball Bearing		-	-	-
	Tacho Signal		-	-	-
	Inlet Adapter		-	-	-
	Outlet Adapter		-	-	-
	Explosion Protection		-	-	-
	Freiblasend		Free blowing		Refoulement libre
	Prüfbarbeitspunkt bei ca. 50% Luftmenge		Inspection working point at approx. 50% air vol.		Point de travail de contrôle appr. à 50% volume d'air
	Druckerhöhung statisch		Pressure difference static		Différence de pression statique

Specifications are subject to change without notice. Specifications on this Datasheet are for reference.